

STEP 4

Attach Panel (B) to Panel (C) and tighten it using Screw (1).

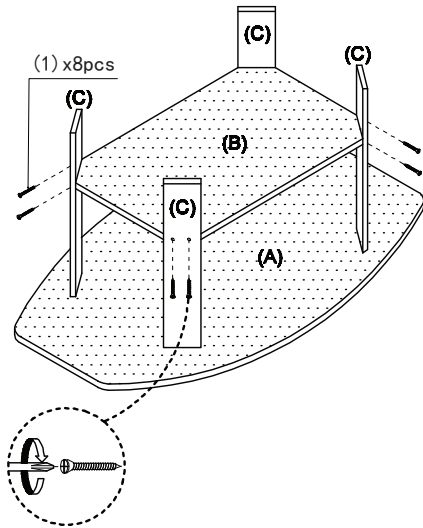

STEP 5

- 5.1 Install Nail Leg (3) to the bottom of Panel (C) using hammer.
- 5.2 Upright the unit.

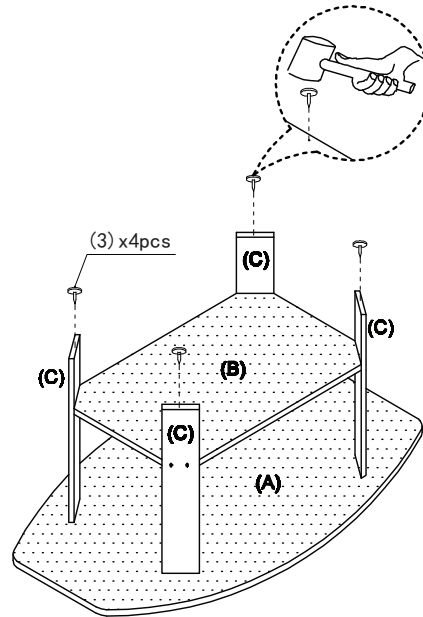

Recommended Maximum Weight

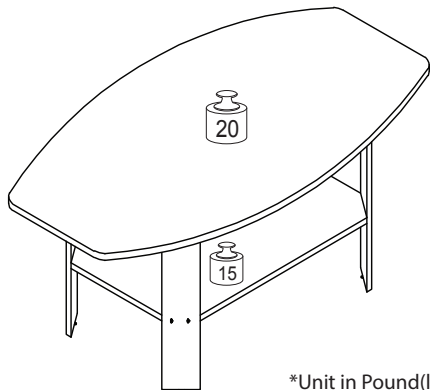

*Unit in Pound(lbs)

WARNING:

>This unit has been designed to support the maximum loads shown. Exceeding these load limits could cause sagging, instability, product collapse, and/or serious injury.

>DO NOT allow children to climb on unit.

>Put heavier items on lower shelves.



Assembly Instruction

Furinno Simple Design Coffee Table

MODEL : **11179**

DIMENSION : 35.5"(W) x 16.3"(H) x 21.5"(D)

00:15

Approx. 15 minutes



Recomm. 1 Person

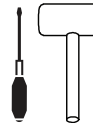

Tools Required

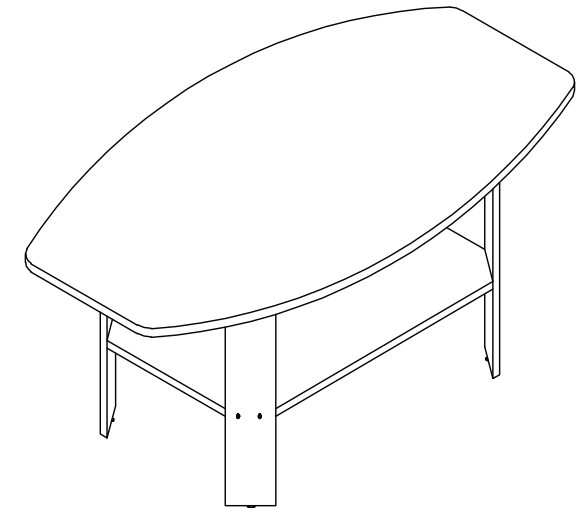

Customer Service

Tel/Fax: 281.500.9372





Toll Free: 773.299.8111 (Mon - Fri 9am - 5pm)



Email: support@furinno.com

www.furinno.com

Find us on
f Facebook

Pinterest

No	Hardware List	Qty
1	Chipboard Screw 	8pcs
2	Plastic Dowel 	8pcs
3	Nail Leg 	4pcs
4	Cam-Lock Nut 	4pcs
5	Cam-Lock Screw 	4pcs

No	Parts List	Qty
A	Top Panel 	1pcs
B	Shelf Panel 	1pcs
C	Leg Panel 	4pcs

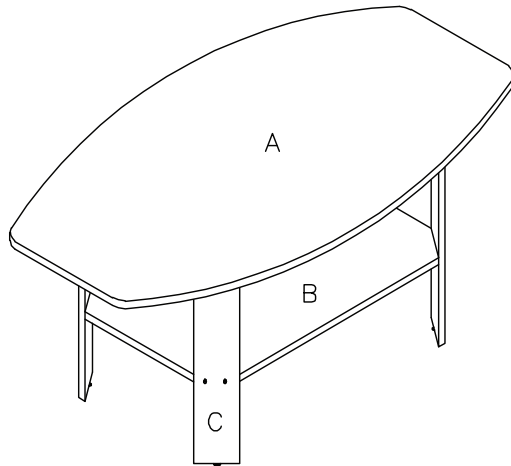

USEFUL HINTS BEFORE YOU START:

1. Read each step carefully before starting.
2. It is important that each step is performed in correct order to avoid difficulties.
3. Identify, sort and count the parts before assembly.
4. Assemble your furniture on packaging cardboard to prevent scratch or damage.
5. Clean the product with mild cleanser using soft damped cloth. Do not use harsh or abrasive cleanser.
6. Using incompatible hardware might cause damage to product.

STEP 1

- 1.1 Insert Dowel (2) to Panel (C).
 - 1.2 Insert Cam-Lock Nut (4) into Panel (C).
- Note: Arrow on Cam-Lock Nut (4) should be pointing towards hole.

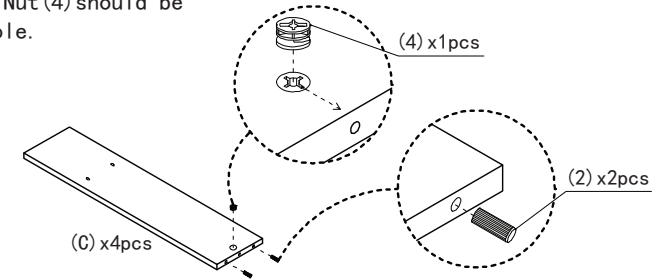

STEP 2

Screw Cam-Lock Screw (5) into pre-drilled holes on Panel (A).

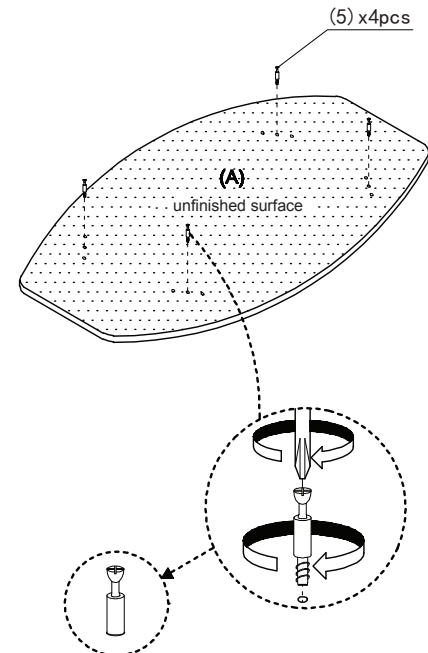

STEP 3

Attach Panel (C) to Panel (A) and tighten Cam-Lock Nut (4) using screwdriver.

